

www.fanmotorsitalia.com



Serie WE Ventilatori assiali a rotore esterno

I ventilatori assiali a rotore esterno serie W sono disponibili in diametri da 250 mm a 630 mm, sia in versione aspirante che premente, 2-4-6 poli con tensione di funzionamento per il monofase 230V - 50/60 Hz e per il trifase 230/380V 50/60 Hz, isolati in classe F e protetti termicamente. Sono disponibili portate d'aria da 870 a 11000 m³/h a 20 Pa.

Poichè la nostra produzione viene costantemente migliorata, gli apparecchi potranno differire nei valori e nelle misure illustrate in questa pubblicazione, quindi misure e valori non sono impegnativi

WE Series External Rotor Axial Fan

W series axial fans are available from 250mm to 630mm diameter, both sucking and blowing type, 2-4-6 poles 230V - 50/60 Hz (single phase) and 230/380V - 50/60 Hz (three phase), with thermal protection and class F insulation. The air flow is available from 870 to 11000 m³/h at 20 Pa.

Due to our constant production improvement, technical devices data here indicated could be modified.

ErP
2015
READY
DIRECTIVE

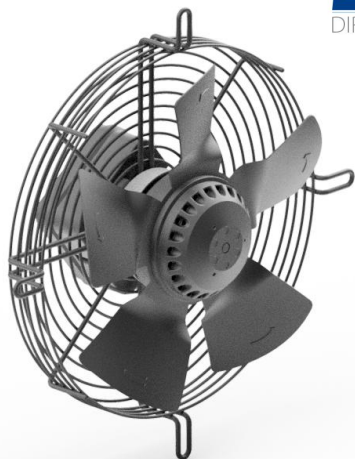

Tipo di servizio: S1
Classe di isolamento: F
Temperatura ambiente: -40°C / +60°C
Classe di protezione: IP54*
Materiale, trattamento superficiale: rotore con foro condensa, verniciato nero, statore protetto contro umidità, griglia verniciata
 I valori di assorbimento si riferiscono alla max efficienza
 *Poiché la nostra produzione viene costantemente migliorata, gli apparecchi potranno differire nei valori e nelle misure illustrate in questa pubblicazione, quindi misure e valori non sono impegnativi

Operating type: S1
Insulation class: F
Ambient temperature: -40°C / +60°C
Protection class: IP54*
Material, surface treatment: rotor with condensation hole, varnished black, humidity proof stator, painted grid
 Absorption values refer to the max efficiency
 *Due to our constant production improvement, technical devices data here indicated could be modified.

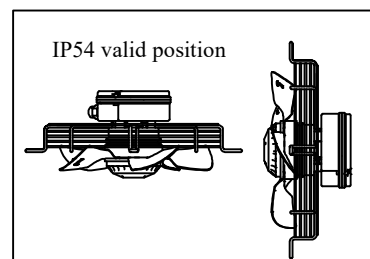
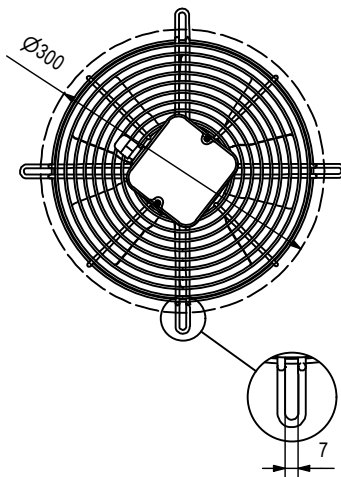
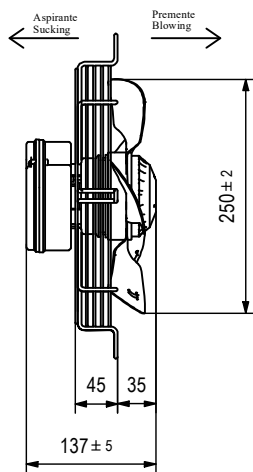
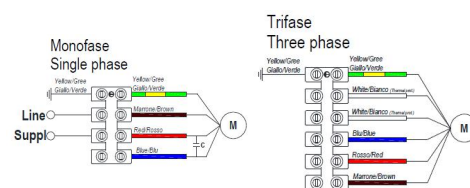

Single phase - Monofase

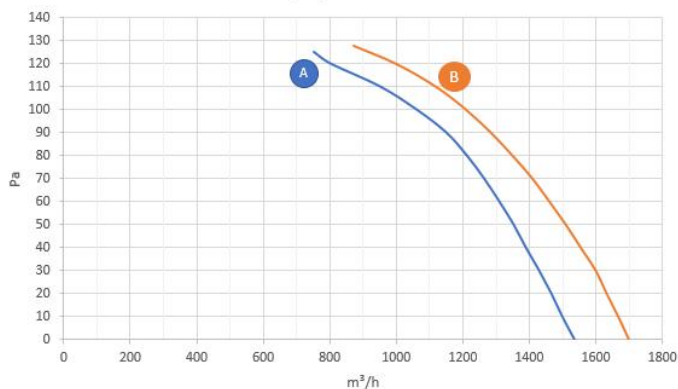

Three Phase - Trifase

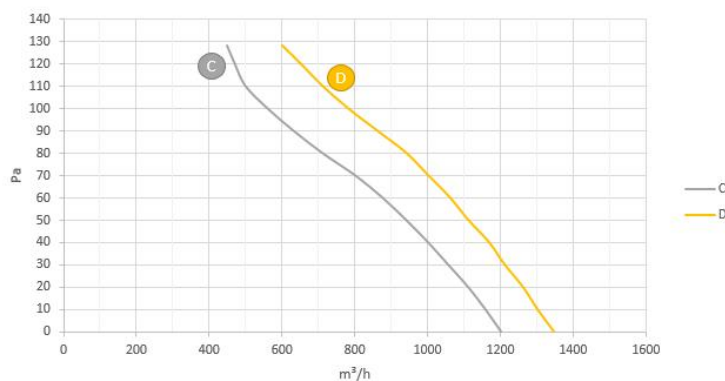

Modello part number	Volt (V)	Frequenza / Frequency (Hz)	Watt in (W)	Corrente / Current (A)	Velocità / Speed (RPM)	Portata / Air flow (m³/h)	Condensatore / Capacitor (µF / V)	Flusso aria / air flow	Db(A)	N	N stat A (%)	Cune
WE5G25(AP)23M251E	230	50	114	0,50	2579	1537	3 / 450	A= aspirante/sucking	68	-	-	A
WE5G25(AP)23M251E	230	60	154	0,67	2739	1700	3 / 450	P= premente/blowing	70	-	-	B
WE5G25(AP)23T 251E	380	50	92	0,24	2616	1200	-	A= aspirante/sucking	68	-	-	C
WE5G25(AP)23T 251E	380	60	103	0,20	2876	1345	-	P= premente/blowing	70	-	-	D

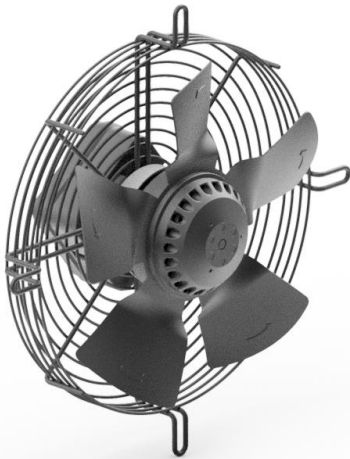

Tipo di servizio: S1
Classe di isolamento: F
Temperatura ambiente: -40°C / +60°C
Classe di protezione: IP54*
Materiale, trattamento superficiale: rotore con foro condensa, verniciato nero, statore protetto contro umidità, griglia verniciata
 I valori di assorbimento si riferiscono alla max efficienza
 *Poiché la nostra produzione viene costantemente migliorata, gli apparecchi potranno differire nei valori e nelle misure illustrate in questa pubblicazione, quindi misure e valori non sono impegnativi

Operating type: S1
Insulation class: F
Ambient temperature: -40°C / +60°C
Protection class: IP54*
Material, surface treatment: rotor with condensation hole, varnished black, humidity proof stator, painted grid
 Absorption values refer to the max efficiency
 *Due to our constant production improvement, technical devices data here indicated could be modified.

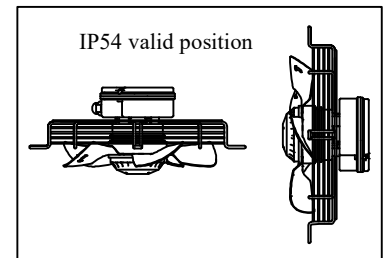
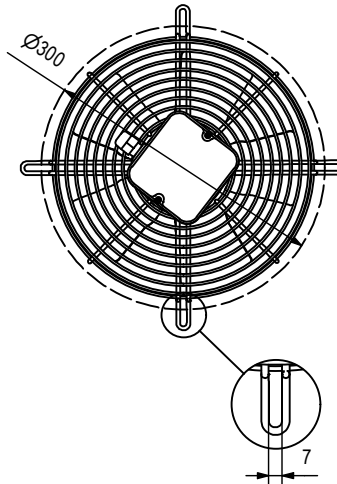
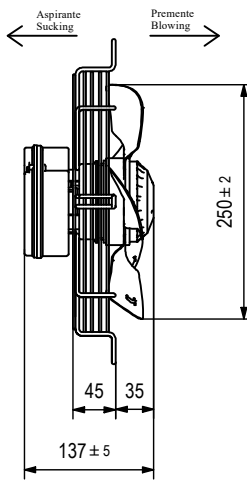
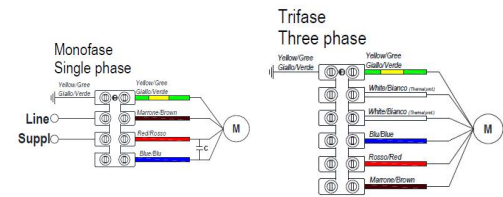

Single phase - Monofase

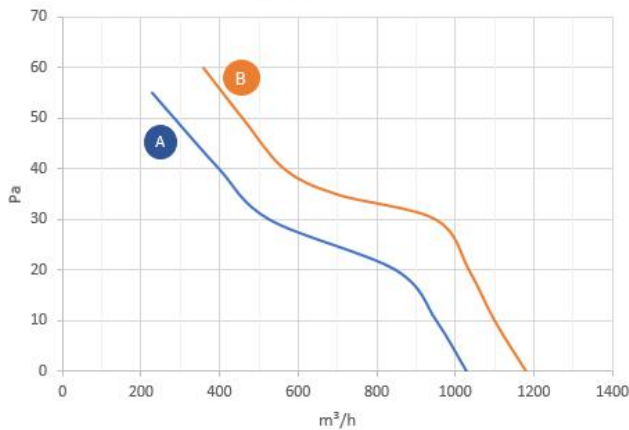

Three phase - Trifase

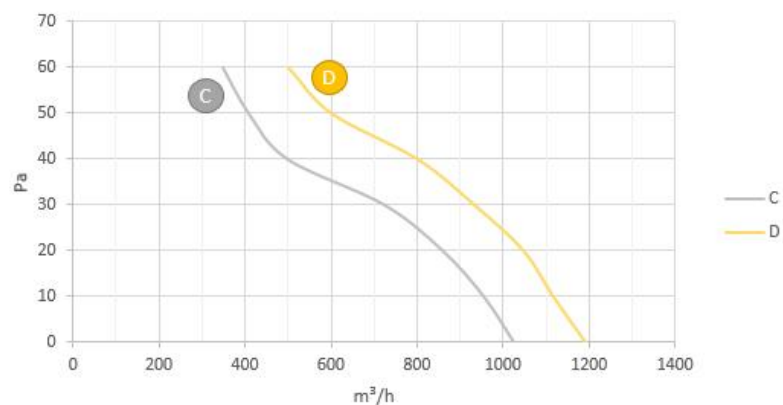

Modello part number	Volt (V)	Frequenza / Frequency (Hz)	Watt in (W)	Corrente / Current (A)	Velocità / Speed (RPM)	Portata / Air flow (m³/h)	Condensatore / Capacitor (µF / V)	Flusso aria / air flow	Db(A)	N	N stat A (%)	Cune
WE5G25(AP)23M451E	230	50	45	0,21	1357	1030	2 / 450	A= aspirante/sucking	54	-	-	A
WE5G25(AP)23M451E	230	60	62	0,29	1581	1180	2 / 450	P= premente/blowing	55	-	-	B
WE5G25(AP)23T451E	380	50	52	0,13	1387	1025	-	A= aspirante/sucking	54	-	-	C
WE5G25(AP)23T451E	380	60	61	0,13	1579	1190	-	P= premente/blowing	55	-	-	D

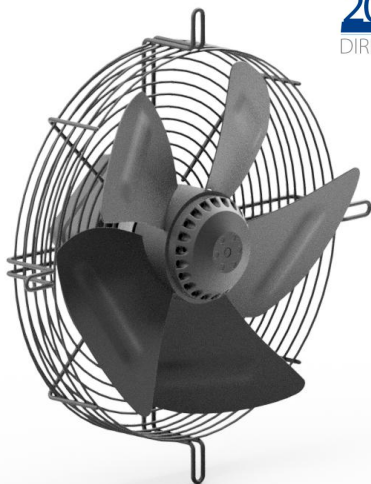

Tipo di servizio: S1
Classe di isolamento: F
Temperatura ambiente: -40°C / +60°C
Classe di protezione: IP54*
Materiale, trattamento superficiale: rotore con foro condensa, verniciato nero, statore protetto contro umidità, griglia verniciata
 I valori di assorbimento si riferiscono alla max efficienza
 *Poiché la nostra produzione viene costantemente migliorata, gli apparecchi potranno differire nei valori e nelle misure illustrate in questa pubblicazione, quindi misure e valori non sono impegnativi

Operating type: S1
Insulation class: F
Ambient temperature: -40°C / +60°C
Protection class: IP54*
Material, surface treatment: rotor with condensation hole, varnished black, humidity proof stator, painted grid
 Absorption values refer to the max efficiency
 *Due to our constant production improvement, technical devices data here indicated could be modified.

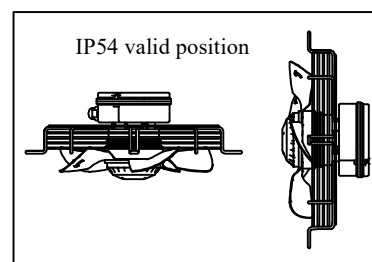
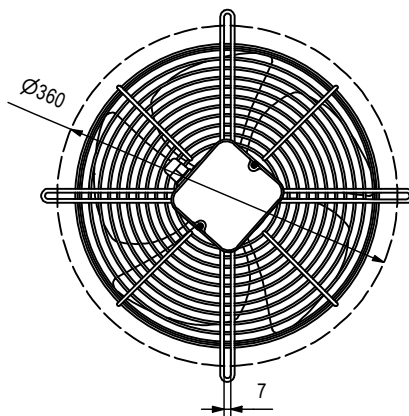
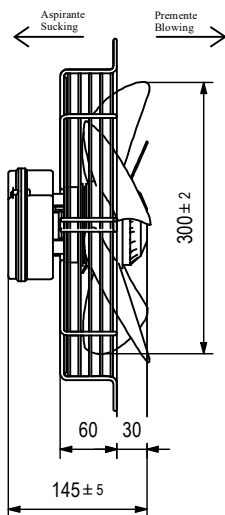
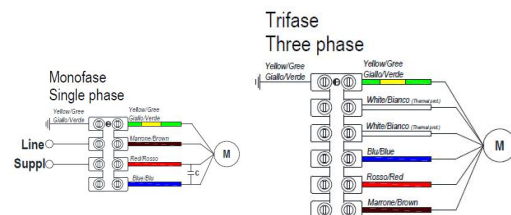

Single phase - Monofase

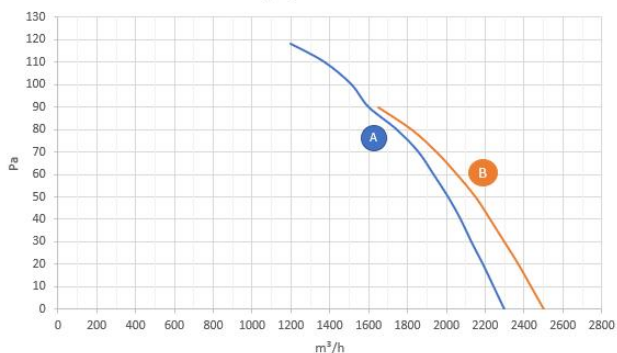

Three Phase - Trifase

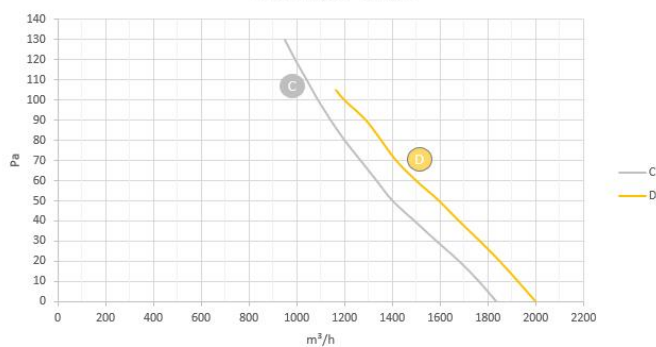

Modello part number	Volt (V)	Frequenza / Frequency (Hz)	Watt in (W)	Corrente / Current (A)	Velocità / Speed (RPM)	Portata / Air flow (m³/h)	Condensatore / Capacitor (µF / V)	Flusso aria / air flow	Db(A)	N	N stat A (%)	Curve
WE5G30(AP)23M251E	230	50	168	0,73	2592	2300	4 / 450V	A= aspirante/sucking	70	-	-	A
WE5G30(AP)23M251E	230	60	239	1,04	2596	2500	4 / 450V	P= premente/blowing	73	-	-	B
WE5G30(AP)23T 251E	380	50	169	0,32	2384	1833	-	A= aspirante/sucking	70	-	-	C
WE5G30(AP)23T 251E	380	60	196	0,33	2610	2000	-	P= premente/blowing	73	-	-	D

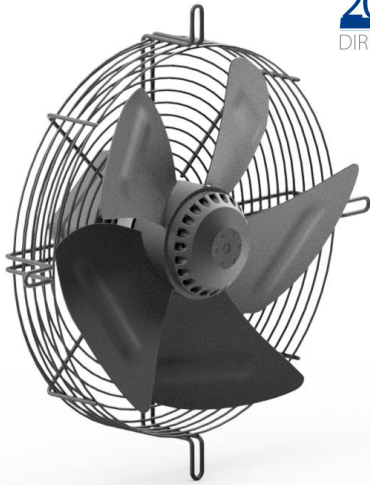

Tipo di servizio: S1
Classe di isolamento: F
Temperatura ambiente: -40°C / +60°C
Classe di protezione: IP54*
Materiale, trattamento superficiale: rotore con foro condensa, verniciato nero, statore protetto contro umidità, griglia verniciata
 I valori di assorbimento si riferiscono alla max efficienza
 *Poiché la nostra produzione viene costantemente migliorata, gli apparecchi potranno differire nei valori e nelle misure illustrate in questa pubblicazione, quindi misure e valori non sono impegnativi

Operating type: S1
Insulation class: F
Ambient temperature: -40°C / +60°C
Protection class: IP54*
Material, surface treatment: rotor with condensation hole, varnished black, humidity proof stator, painted grid
 Absorption values refer to the max efficiency
 *Due to our constant production improvement, technical devices data here indicated could be modified.

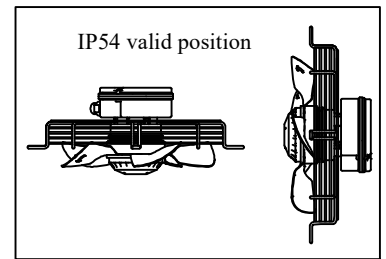
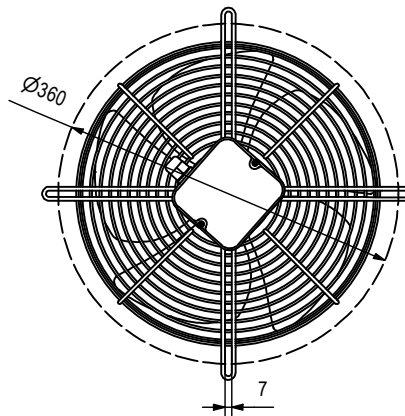
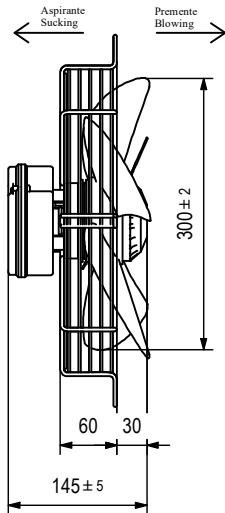
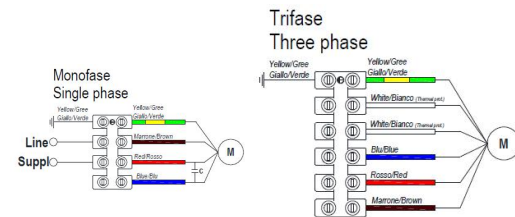

Single phase - Monofase

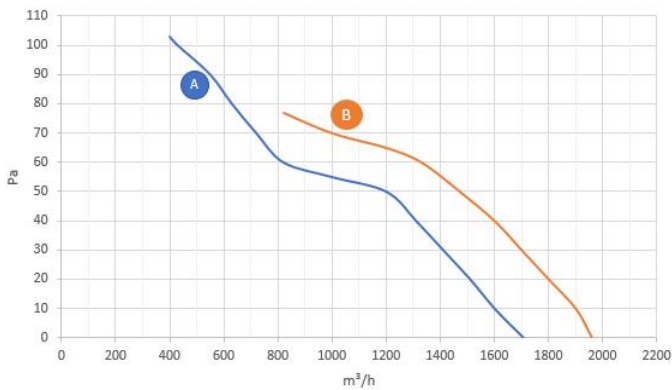

Three Phase - Trifase

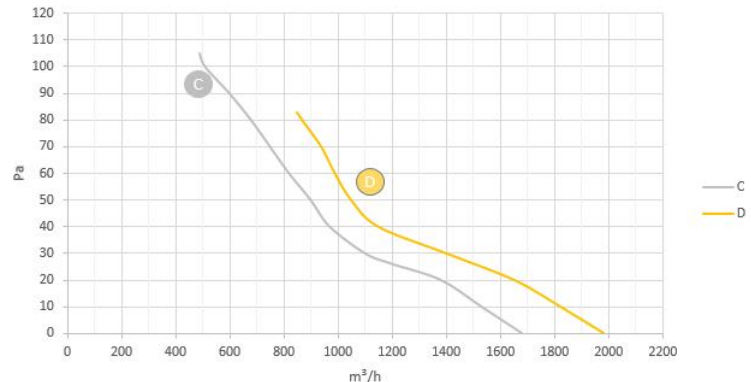

Modello part number	Volt (V)	Frequenza / Frequency (Hz)	Watt in (W)	Corrente / Current (A)	Velocità / Speed (RPM)	Portata / Air flow (m³/h)	Condensatore / Capacitor (µF / V)	Flusso aria / air flow	Db(A)	N	N stat A (%)	Curve
WE5G30(AP)23M451E	230	50	88	0,37	1355	1707	3/450	A= aspirante/sucking	58	-	-	A
WE5G30(AP)23M451E	230	60	112	0,48	1546	1960	3/450	P= premente/blowing	61	-	-	B
WE5G30(AP)23T451E	380	50	108	0,23	1345	1680	-	A= aspirante/sucking	58	-	-	C
WE5G30(AP)23T451E	380	60	106	0,22	1596	1980	-	P= premente/blowing	62	-	-	D

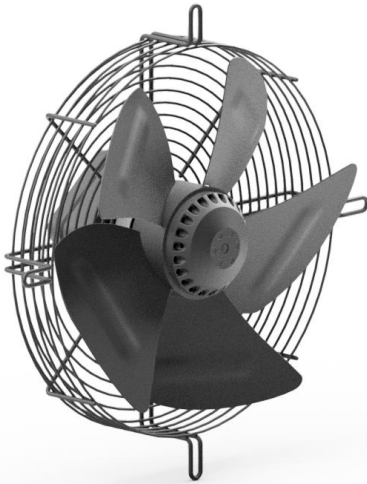

Tipo di servizio: S1
Classe di isolamento: F
Temperatura ambiente: -40°C / +60°C
Classe di protezione: IP54*
Materiale, trattamento superficiale: rotore con foro condensa, verniciato nero, statore protetto contro umidità, griglia verniciata
 I valori di assorbimento si riferiscono alla max efficienza
 *Poiché la nostra produzione viene costantemente migliorata, gli apparecchi potranno differire nei valori e nelle misure illustrate in questa pubblicazione, quindi misure e valori non sono impegnativi

Operating type: S1
Insulation class: F
Ambient temperature: -40°C / +60°C
Protection class: IP54*
Material, surface treatment: rotor with condensation hole, varnished black, humidity proof stator, painted grid
 Absorption values refer to the max efficiency
 *Due to our constant production improvement, technical devices data here indicated could be modified.

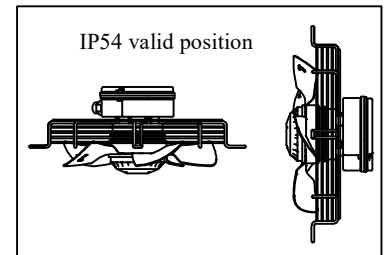
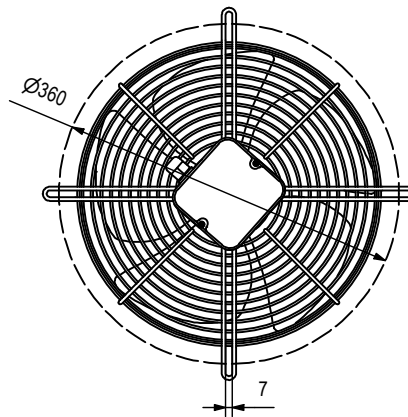
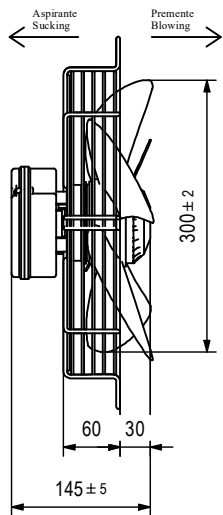
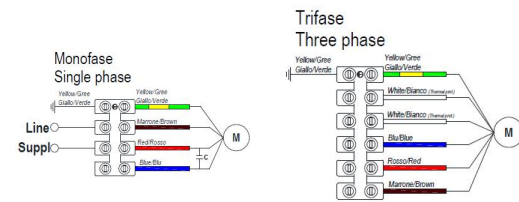

Single phase - Monofase

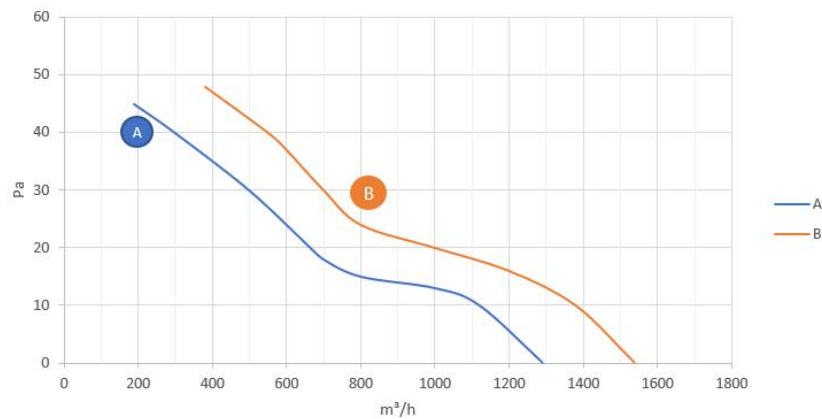

Modello part number	Volt (V)	Frequenza / Frequency (Hz)	Watt in (W)	Corrente / Current (A)	Velocità / Speed (RPM)	Portata / Air flow (m³/h)	Condensatore / Capacitor (µF / V)	Flusso aria / air flow	Db(A)	N	N stat A (%)	Curve
WE5G30(AP)23M651E	230	50	53	0,24	886	1291	2 / 450	A= aspirante/sucking	55	-	-	A
WE5G30(AP)23M651E	230	60	66	0,30	1007	1540	2 / 450	P= premente/blowing	56	-	-	B

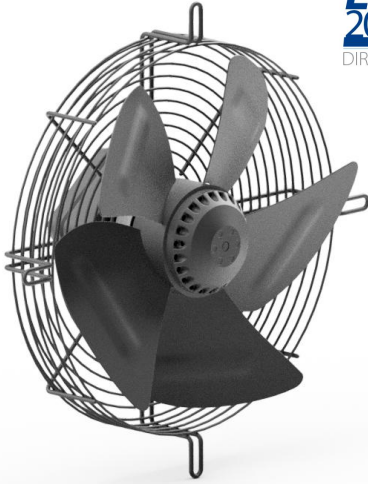

Tipo di servizio: S1
Classe di isolamento: F
Temperatura ambiente: -40°C / +60°C
Classe di protezione: IP54*
Materiale, trattamento superficiale: rotore con foro condensa, verniciato nero, statore protetto contro umidità, griglia verniciata
 I valori di assorbimento si riferiscono alla max efficienza
 *Poiché la nostra produzione viene costantemente migliorata, gli apparecchi potranno differire nei valori e nelle misure illustrate in questa pubblicazione, quindi misure e valori non sono impegnativi

Operating type: S1
Insulation class: F
Ambient temperature: -40°C / +60°C
Protection class: IP54*
Material, surface treatment: rotor with condensation hole, varnished black, humidity proof stator, painted grid
 Absorption values refer to the max efficiency
 *Due to our constant production improvement, technical devices data here indicated could be modified.

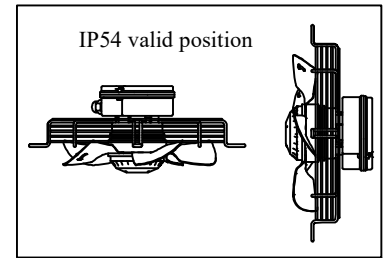
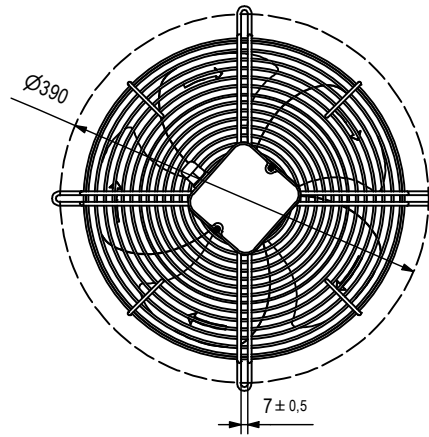
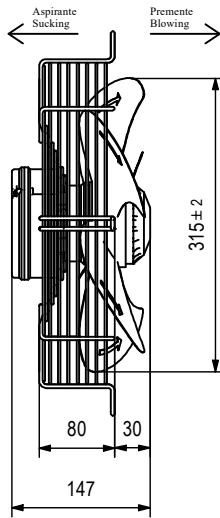
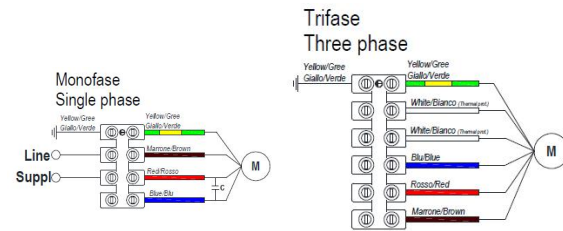

Single phase - Monofase

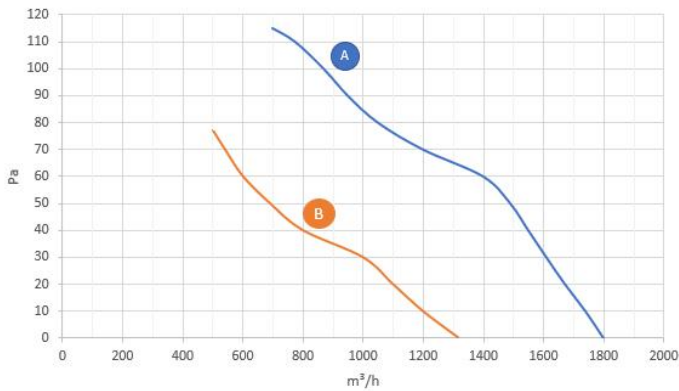

Three Phase - Trifase

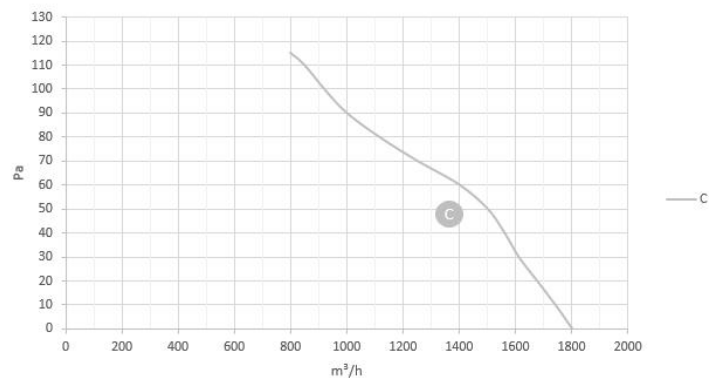

Modello part number	Volt (V)	Frequenza / Frequency (Hz)	Watt in (W)	Corrente / Current (A)	Velocità / Speed (RPM)	Portata / Air flow (m³/h)	Condensatore / Capacitor (µF / V)	Flusso aria / air flow	Db(A)	N	N stat A (%)	Cune
WE5G31(AP)23M451E	230	50	90	0,43	1380	1800	3 / 450	A= Aspirante/Sucking B= Premente/Blowing	60	-	-	A
WE5G31(AP)23M651E	230	50	60	0,29	920	1320	2 / 450		60	-	-	B
WE5G31(AP)23T451E	380	50	90	0,30	1380	1800	-		56	-	-	C

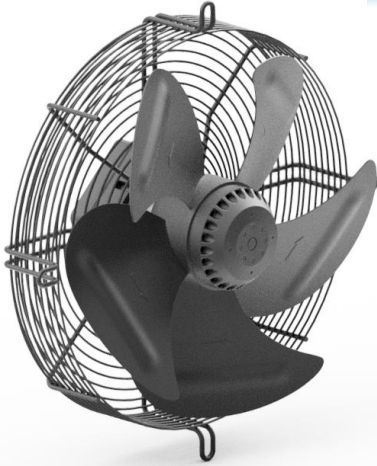

Tipo di servizio: S1
Classe di isolamento: F
Temperatura ambiente: -40°C / +60°C
Classe di protezione: IP54*
Materiale, trattamento superficiale: rotore con foro condensa, verniciato nero, statore protetto contro umidità, griglia verniciata
 I valori di assorbimento si riferiscono alla max efficienza
 *Poichè la nostra produzione viene costantemente migliorata, gli apparecchi potranno differire nei valori e nelle misure illustrate in questa pubblicazione, quindi misure e valori non sono impegnativi

Operating type: S1
Insulation class: F
Ambient temperature: -40°C / +60°C
Protection class: IP54*
Material, surface treatment: rotor with condensation hole, varnished black, humidity proof stator, painted grid
 Absorption values refer to the max efficiency
 *Due to our constant production improvement, technical devices data here indicated could be modified.

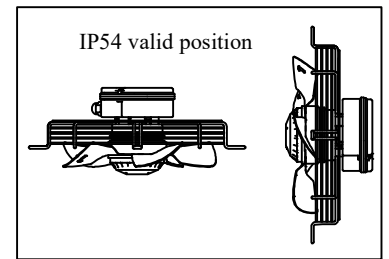
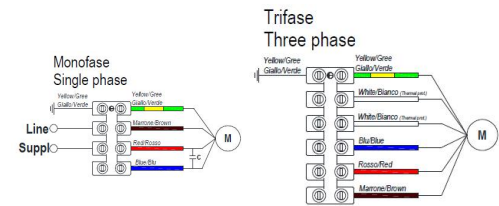
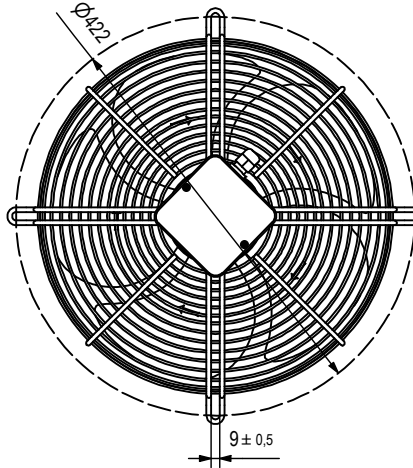
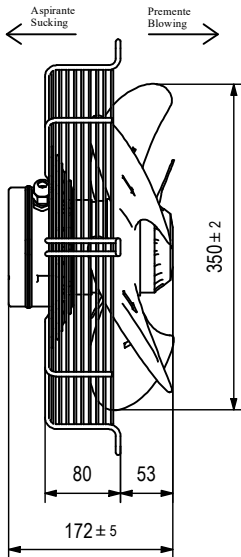

Single phase - Monofase

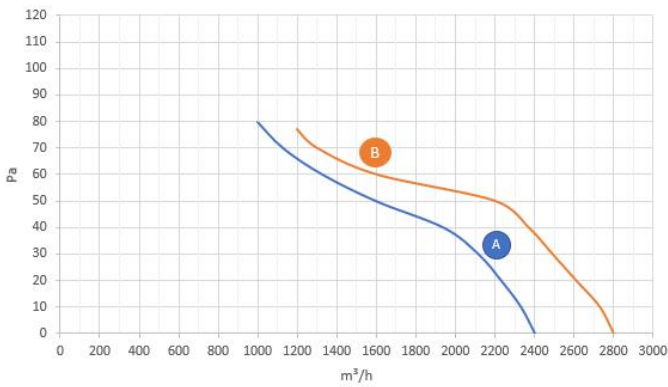

Three Phase - Trifase

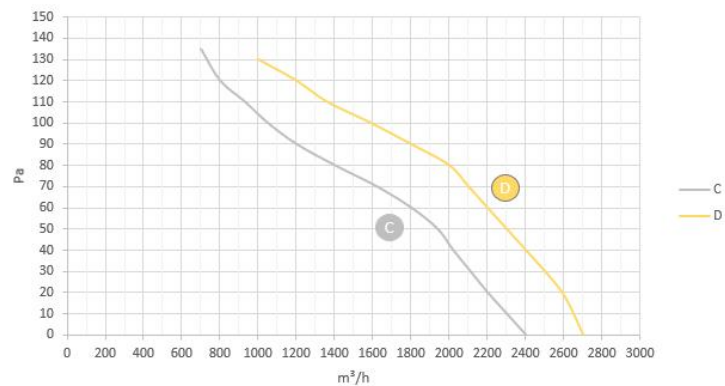

Modello part number	Volt (V)	Frequenza / Frequency (Hz)	Watt in (W)	Corrente / Current (A)	Velocità / Speed (RPM)	Portata / Air flow (m³/h)	Condensatore / Capacitor (µF / V)	Flusso aria / air flow	Db(A)	N	N stat A (%)	Curve
WE5G35(AP)30M451E	230	50	118	0,56	1387	2400	4 / 450	A= aspirante/sucking	62	-	-	A
WE5G35(AP)30M451E	230	60	161	0,73	1575	2800	4 / 450	P= premente/blowing	66	-	-	B
WE5G35(AP)30T451E	380	50	121	0,28	1397	2400	-	A= aspirante/sucking	63	-	-	C
WE5G35(AP)30T451E	380	60	160	0,30	1556	2700	-	P= premente/blowing	66	-	-	D

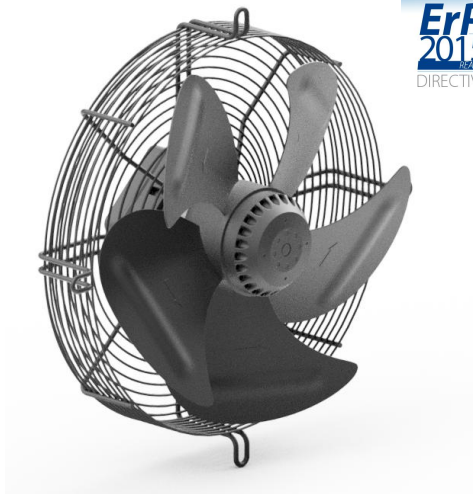

Tipo di servizio: S1
Classe di isolamento: F
Temperatura ambiente: -40°C / +60°C
Classe di protezione: IP54*
Materiale, trattamento superficiale: rotore con foro condensa, verniciato nero, statore protetto contro umidità, griglia verniciata
 I valori di assorbimento si riferiscono alla max efficienza
 *Poichè la nostra produzione viene costantemente migliorata, gli apparecchi potranno differire nei valori e nelle misure illustrate in questa pubblicazione, quindi misure e valori non sono impegnativi

Operating type: S1
Insulation class: F
Ambient temperature: -40°C / +60°C
Protection class: IP54*
Material, surface treatment: rotor with condensation hole, varnished black, humidity proof stator, painted grid
 Absorption values refer to the max efficiency
 *Due to our constant production improvement, technical devices data here indicated could be modified.

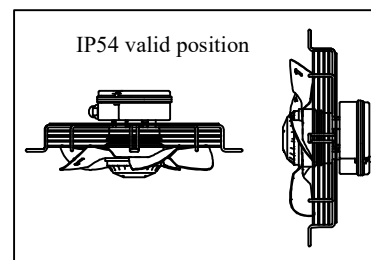
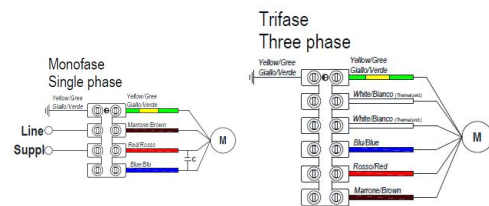
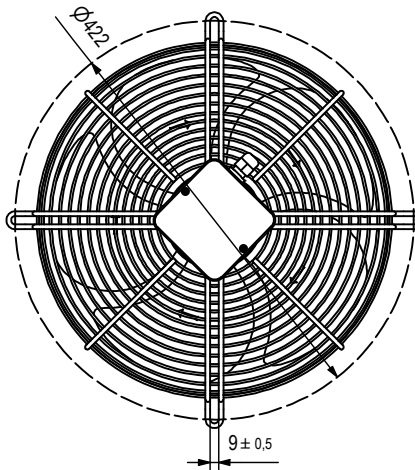
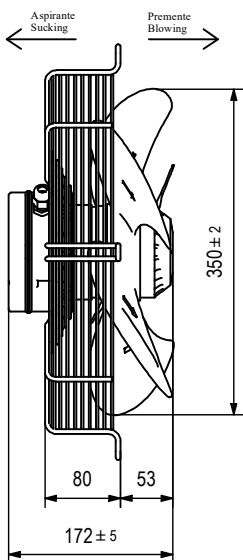

Single phase - Monofase

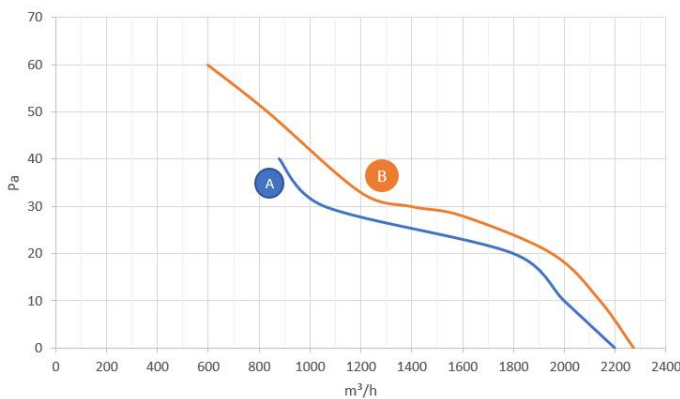

Modello part number	Volt (V)	Frequenza / Frequency (Hz)	Watt in (W)	Corrente / Current (A)	Velocità / Speed (RPM)	Portata / Air flow (m³/h)	Condensatore / Capacitor (µF / V)	Flusso aria / air flow	Db(A)	N	N stat A (%)	Curve
WE5G35(A/P)30M651E	230	50	92	0,26	918	2200	4 / 450	A= aspirante/sucking	57	-	-	A
WE5G35(A/P)30M651E	230	60	107	0,24	1041	2272	4 / 450	P= premente/blowing	58	-	-	B

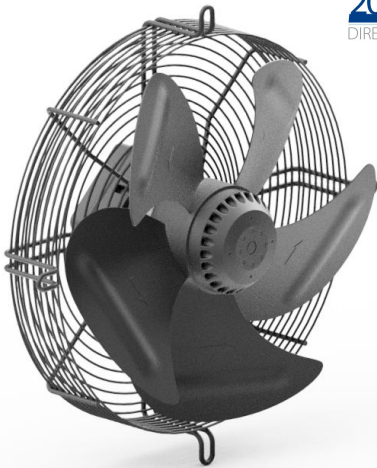

Tipo di servizio: S1
Classe di isolamento: F
Temperatura ambiente: -40°C / +60°C
Classe di protezione: IP54*
Materiale, trattamento superficiale: rotore con foro condensa, verniciato nero, statore protetto contro umidità, griglia verniciata
 I valori di assorbimento si riferiscono alla max efficienza
 *Poichè la nostra produzione viene costantemente migliorata, gli apparecchi potranno differire nei valori e nelle misure illustrate in questa pubblicazione, quindi misure e valori non sono impegnativi

Operating type: S1
Insulation class: F
Ambient temperature: -40°C / +60°C
Protection class: IP54*
Material, surface treatment: rotor with condensation hole, varnished black, humidity proof stator, painted grid
 Absorption values refer to the max efficiency
 *Due to our constant production improvement, technical devices data here indicated could be modified.

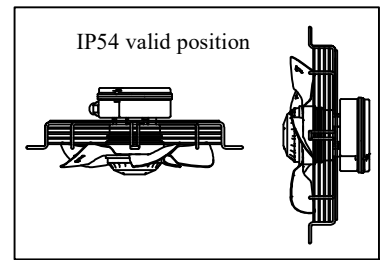
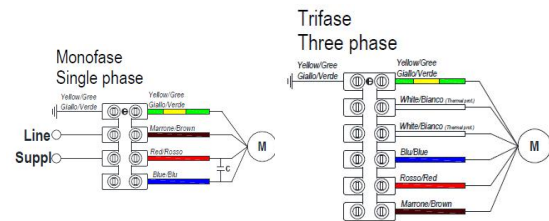
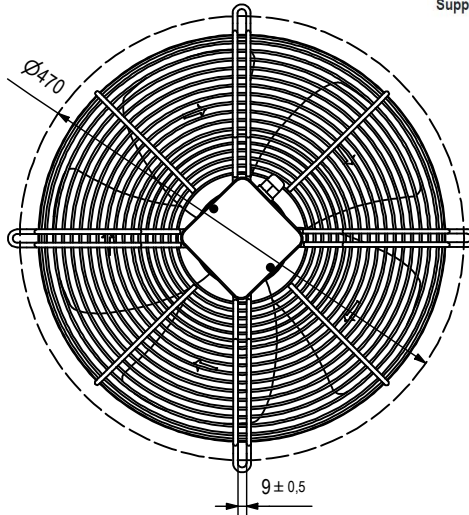
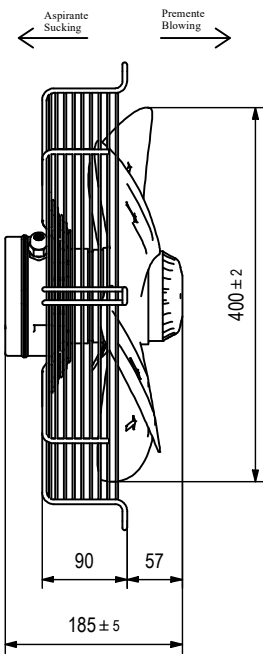

Single phase - Monofase

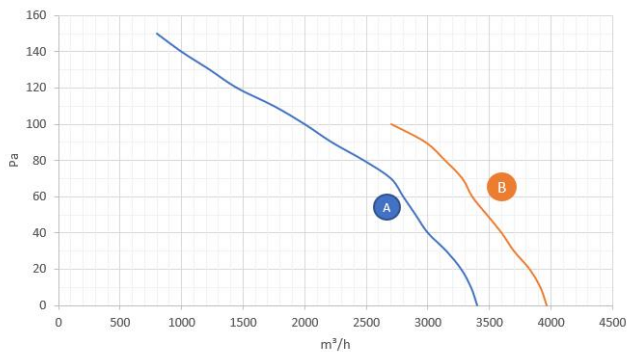

Three Phase - Trifase

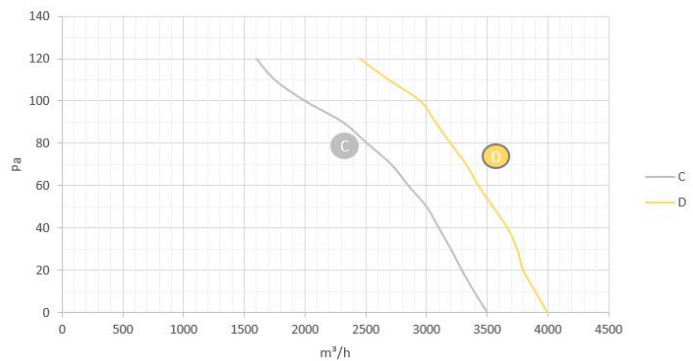

Modello part number	Volt (V)	Frequenza / Frequency (Hz)	Watt in (W)	Corrente / Current (A)	Velocità / Speed (RPM)	Portata / Air flow (m³/h)	Condensatore / Capacitor (µF / V)	Flusso aria / air flow	Db(A)	N	N stat A (%)	Curve
WE5G40(AP)23M451K	230	50	179	0,84	1378	3400	6 / 450	A= aspirante/sucking	67	41,9	30,93	A
WE5G40(AP)23M451K	230	60	241	1,10	1564	3967	6 / 450	P= premente/blowing	69	30,08	40,2	B
WE5G40(AP)23T451K	380	50	186	0,44	1383	3500	-	A= aspirante/sucking	67	31,92	42,7	C
WE5G40(AP)23T451K	380	60	238	0,45	1587	4000	-	P= premente/blowing	69	31,48	41,6	D

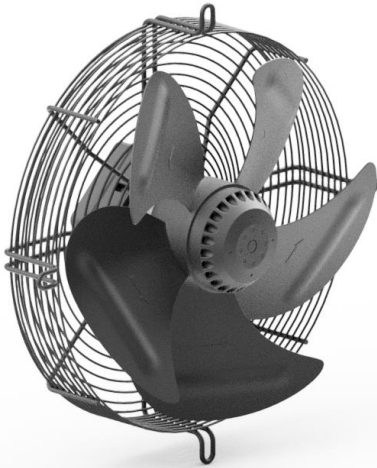

Tipo di servizio: S1
Classe di isolamento: F
Temperatura ambiente: -40°C / +60°C
Classe di protezione: IP54*
Materiale, trattamento superficiale: rotore con foro condensa, verniciato nero, statore protetto contro umidità, griglia verniciata
 I valori di assorbimento si riferiscono alla max efficienza
 *Poichè la nostra produzione viene costantemente migliorata, gli apparecchi potranno differire nei valori e nelle misure illustrate in questa pubblicazione, quindi misure e valori non sono impegnativi

Operating type: S1
Insulation class: F
Ambient temperature: -40°C / +60°C
Protection class: IP54*
Material, surface treatment: rotor with condensation hole, varnished black, humidity proof stator, painted grid
 Absorption values refer to the max efficiency
 *Due to our constant production improvement, technical devices data here indicated could be modified.

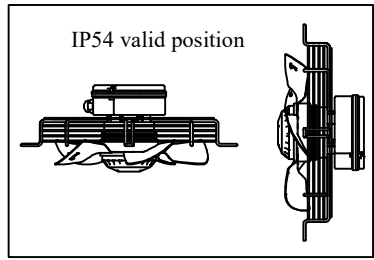
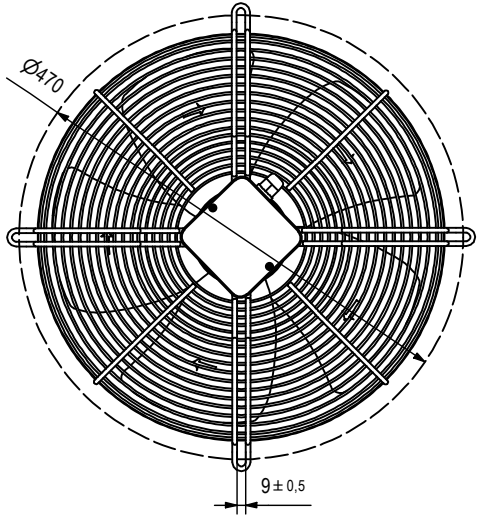
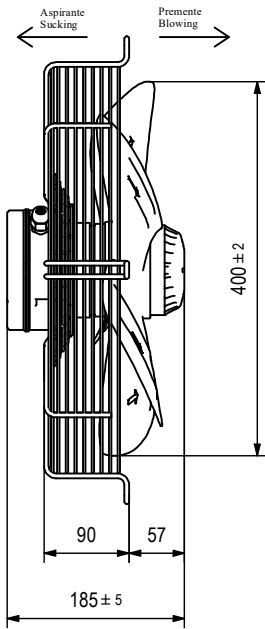
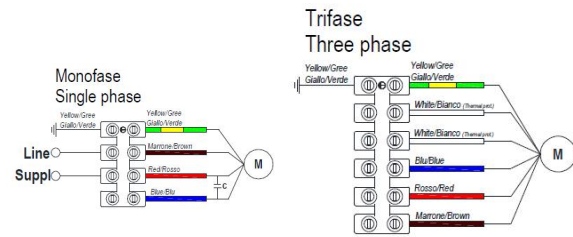

Single phase - Monofase

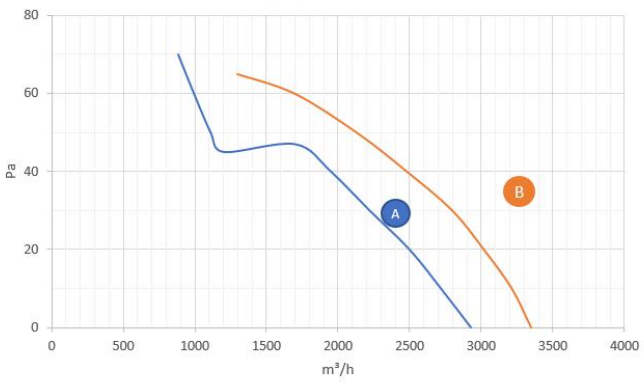

Three Phase - Trifase

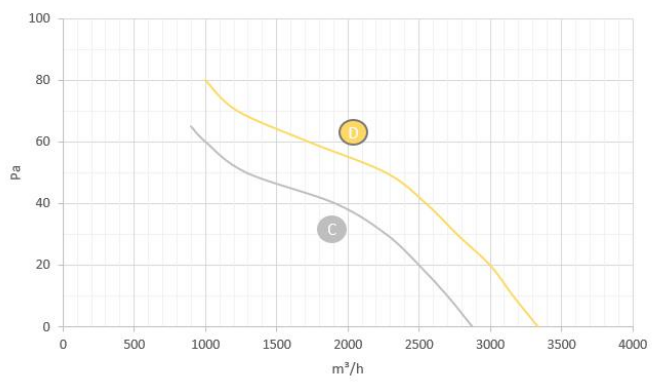

Modello part number	Volt (V)	Frequenza / Frequency (Hz)	Watt in (W)	Corrente / Current (A)	Velocità / Speed (RPM)	Portata / Air flow (m³/h)	Condensatore / Capacitor (µF / V)	Flusso aria / air flow	Db(A)	N	N stat A (%)	Curve
WE5G40(AP)23M651E	230	50	113	0,52	909	2930	5 / 450	A= aspirante/sucking	58	-	-	A
WE5G40(AP)23M651E	230	60	145	0,68	1040	3350	5 / 450	P= premente/blowing	59	-	-	B
WE5G40(AP)23T 651E	380	50	118	0,36	922	2875	-	A= aspirante/sucking	58	-	-	C
WE5G40(AP)23T 651E	380	60	146	0,33	1055	3337	-	P= premente/blowing	60	-	-	D

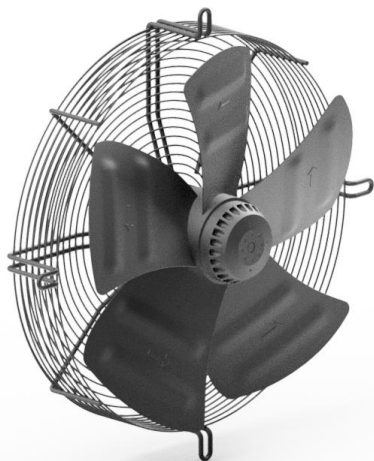

Tipo di servizio: S1
Classe di isolamento: F
Temperatura ambiente: -40°C / +60°C
Classe di protezione: IP54*
Materiale, trattamento superficiale: rotore con foro condensa, verniciato nero, statore protetto contro umidità, griglia verniciata
 I valori di assorbimento si riferiscono alla max efficienza
 *Poichè la nostra produzione viene costantemente migliorata, gli apparecchi potranno differire nei valori e nelle misure illustrate in questa pubblicazione, quindi misure e valori non sono impegnativi

Operating type: S1
Insulation class: F
Ambient temperature: -40°C / +60°C
Protection class: IP54*
Material, surface treatment: rotor with condensation hole, varnished black, humidity proof stator, painted grid
 Absorption values refer to the max efficiency
 *Due to our constant production improvement, technical devices data here indicated could be modified.

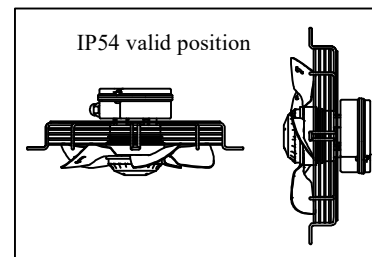
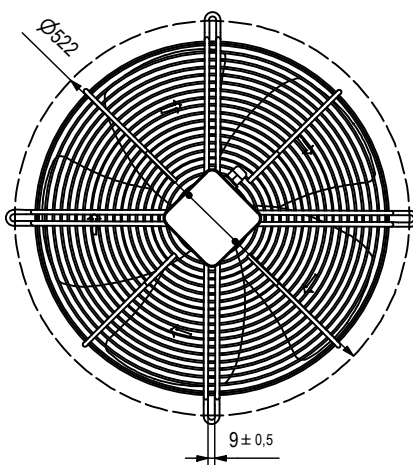
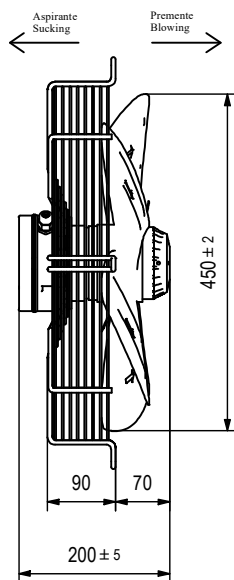

Monofase - Single phase

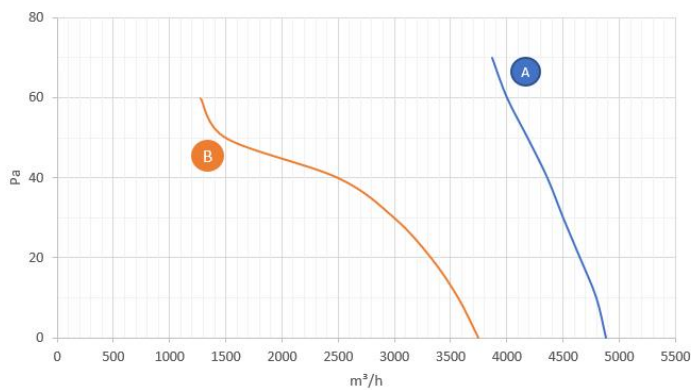

Trifase - Three phase

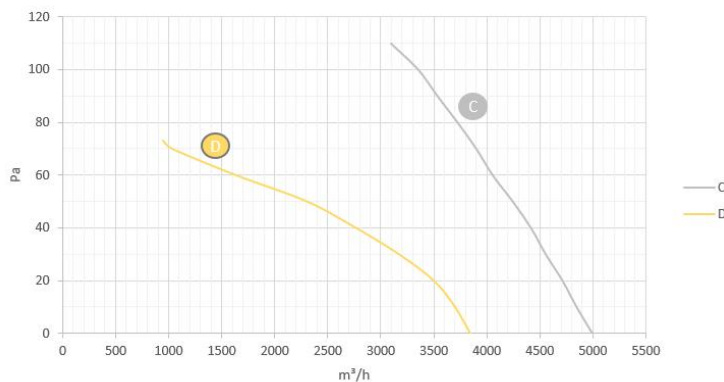

Modello part number	Volt (V)	Frequenza / Frequency (Hz)	Watt in (W)	Corrente / Current (A)	Velocità / Speed (RPM)	Portata / Air flow (m³/h)	Condensatore / Capacitor (µF / V)	Flusso aria / air flow	Db(A)	N	N stat A (%)	Curve
WE5G45(AP)23M451K	230	50	249	1,13	1339	4882	8	A= aspirante/sucking	69	40,5	30,47	A
WE5G45(AP)23M651E	230	50	149	0,70	891	3750	6	P= premente/blowing	60	/	/	B
WE5G45(AP)23T451K	380	50	290	0,59	1328	5000	-	A= aspirante/sucking	69	42	32,36	C
WE5G45(AP)23T651E	380	50	166	0,51	912	3843	-	P= premente/blowing	60	/	/	D

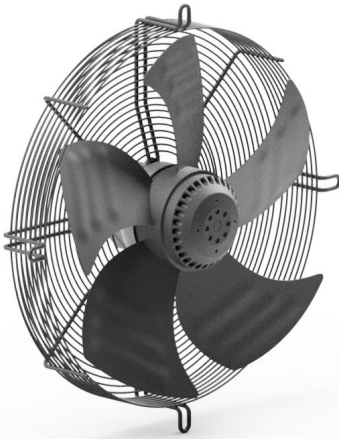

Tipo di servizio: S1
Classe di isolamento: F
Temperatura ambiente: -40°C / +60°C
Classe di protezione: IP54*
Materiale, trattamento superficiale: rotore con foro condensa, verniciato nero, statore protetto contro umidità, griglia verniciata
 I valori di assorbimento si riferiscono alla max efficienza
 *Poiché la nostra produzione viene costantemente migliorata, gli apparecchi potranno differire nei valori e nelle misure illustrate in questa pubblicazione, quindi misure e valori non sono impegnativi

Operating type: S1
Insulation class: F
Ambient temperature: -40°C / +60°C
Protection class: IP54*
Material, surface treatment: rotor with condensation hole, varnished black, humidity proof stator, painted grid
 Absorption values refer to the max efficiency
 *Due to our constant production improvement, technical devices data here indicated could be modified.

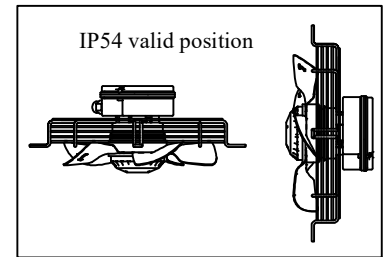
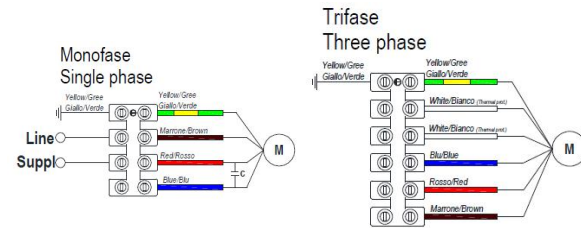
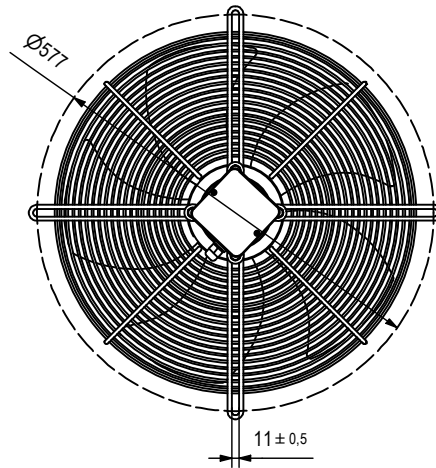
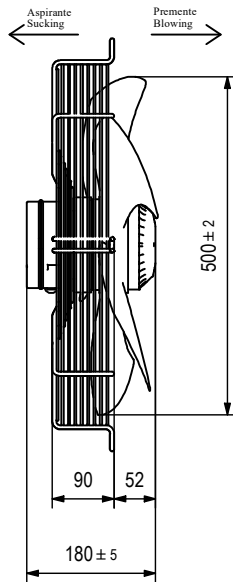

Monofase - Single phase

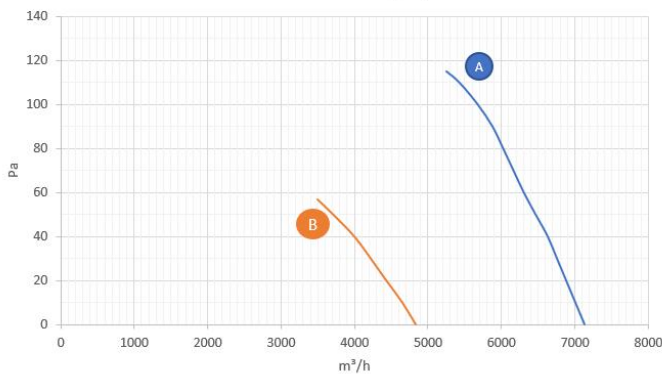

Trifase - Three phase

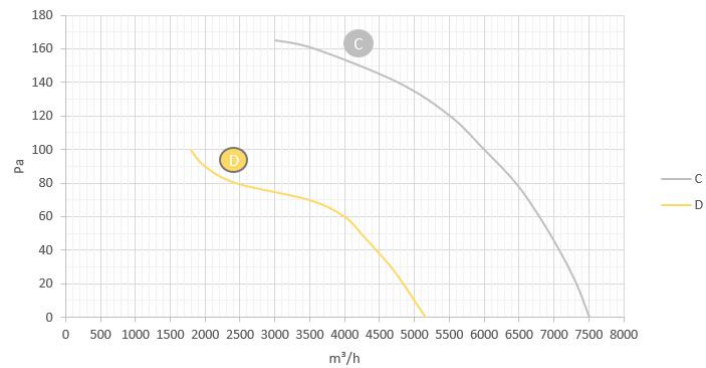

Modello part number	Volt (V)	Frequenza / Frequency (Hz)	Watt in (W)	Corrente / Current (A)	Velocità / Speed (RPM)	Portata / Air flow (m³/h)	Condensatore / Capacitor (µF / V)	Flusso aria / air flow	Db(A)	N	N stat A (%)	Curve
WE5G50(AP)23M451K	230	50	513	2,33	1345	7125	12 / 450	A= aspirante/sucking	71	40,7	32,6	A
WE5G50(AP)23M651K	230	50	183	0,84	894	4827	8 / 450	P= premente/blowing	65	40,7	29,82	B
WE5G50(AP)23T451K	380	50	548	1,10	1381	7510	-	A= aspirante/sucking	72	40,4	32,58	C
WE5G50(AP)23T651K	380	50	214	0,58	934	5159	-	P= premente/blowing	66	42	34,54	D

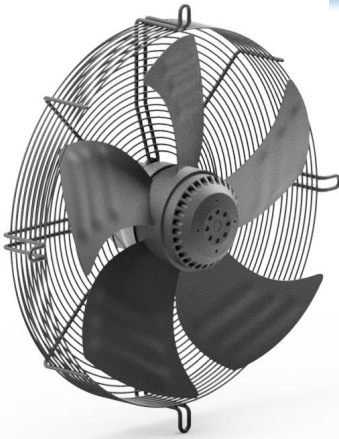

Tipo di servizio: S1
Classe di isolamento: F
Temperatura ambiente: -40°C / +60°C
Classe di protezione: IP54*
Materiale, trattamento superficiale: rotore con foro condensa, verniciato nero, statore protetto contro umidità, griglia verniciata
 I valori di assorbimento si riferiscono alla max efficienza
 *Poiché la nostra produzione viene costantemente migliorata, gli apparecchi potranno differire nei valori e nelle misure illustrate in questa pubblicazione, quindi misure e valori non sono impegnativi

Operating type: S1
Insulation class: F
Ambient temperature: -40°C / +60°C
Protection class: IP54*
Material, surface treatment: rotor with condensation hole, varnished black, humidity proof stator, painted grid
 Absorption values refer to the max efficiency
 *Due to our constant production improvement, technical devices data here indicated could be modified.

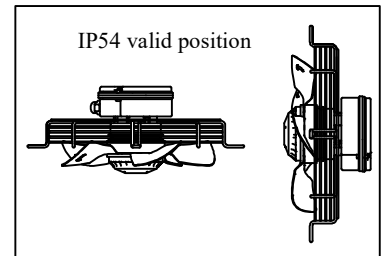
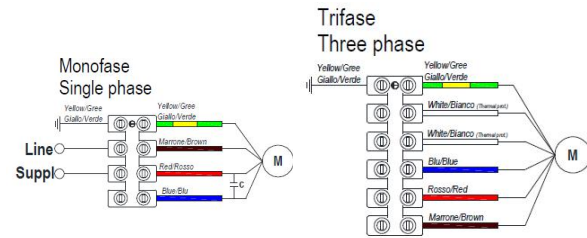
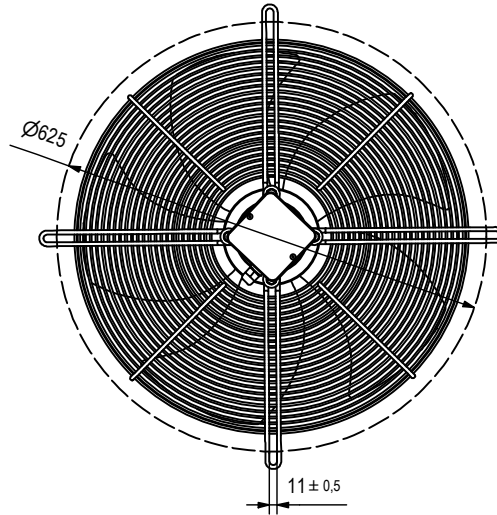
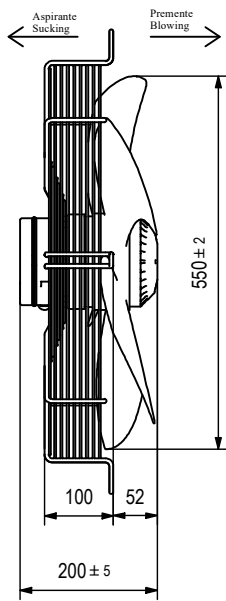

Monofase - Single phase

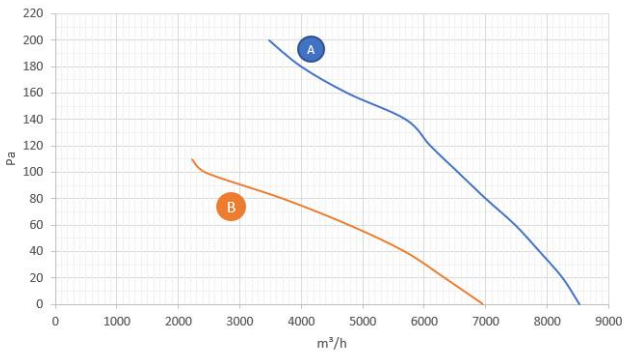

Trifase - Three phase

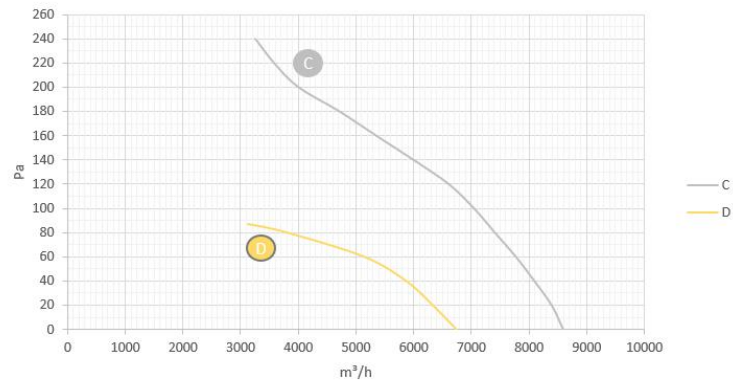

Modello part number	Volt (V)	Frequenza / Frequency (Hz)	Watt in (W)	Corrente / Current (A)	Velocità / Speed (RPM)	Portata / Air flow (m³/h)	Condensatore / Capacitor (µF / V)	Flusso aria / air flow	Db(A)	N	N stat A (%)	Curve
WE5G55(AP)23M451K	230	50	639	2,90	1361	8525	16 / 450	A= aspirante/sucking	74	40,2	32,8	A
WE5G55(AP)23M651E	230	50	348	1,59	897	6950	12 / 450	P= premente/blowing	69	33	23,85	B
WE5G55(AP)23T451K	380	50	670	1,27	1377	8600	-	A= aspirante/sucking	74	42,7	35,4	C
WE5G55(AP)23T651K	380	50	295	0,69	921	6750	-	P= premente/blowing	67	31,8	41,4	D

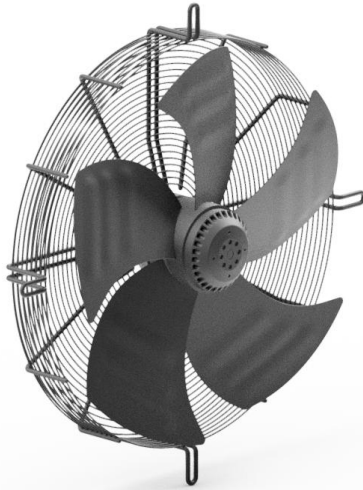

Tipo di servizio: S1
Classe di isolamento: F
Temperatura ambiente: -40°C / +60°C
Classe di protezione: IP54*
Materiale, trattamento superficiale: rotore con foro condensa, verniciato nero, statore protetto contro umidità, griglia verniciata
 I valori di assorbimento si riferiscono alla max efficienza
 *Poichè la nostra produzione viene costantemente migliorata, gli apparecchi potranno differire nei valori e nelle misure illustrate in questa pubblicazione, quindi misure e valori non sono impegnativi

Operating type: S1
Insulation class: F
Ambient temperature: -40°C / +60°C
Protection class: IP54*
Material, surface treatment: rotor with condensation hole, varnished black, humidity proof stator, painted grid
 Absorption values refer to the max efficiency
 *Due to our constant production improvement, technical devices data here indicated could be modified.

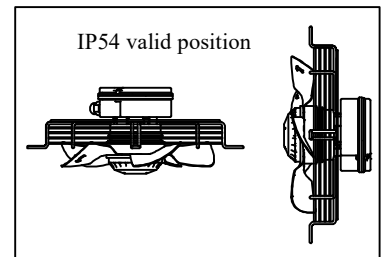
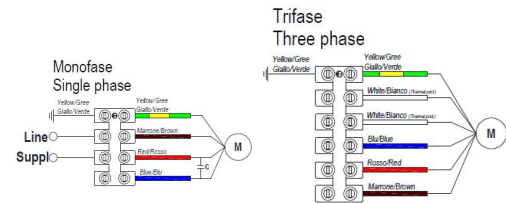
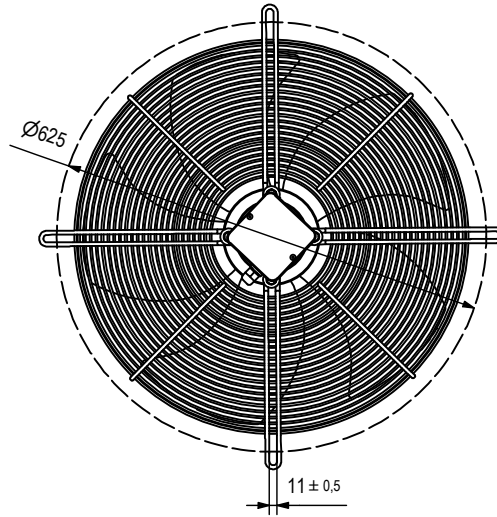
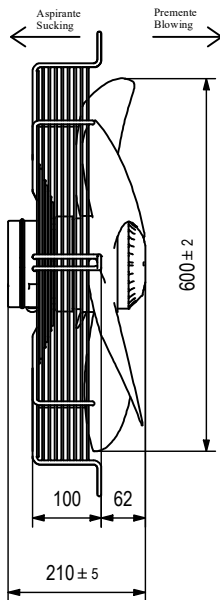

Monofase - Single phase

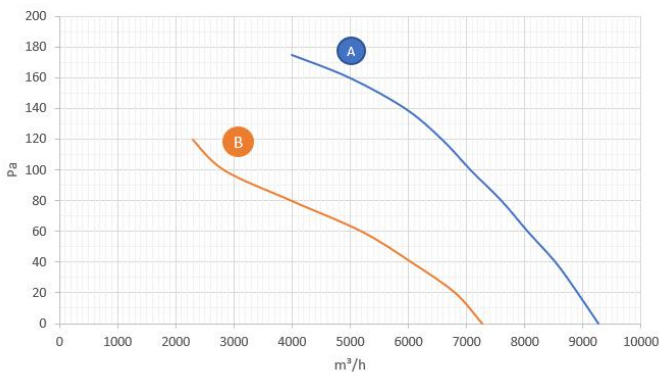

Trifase - Three phase

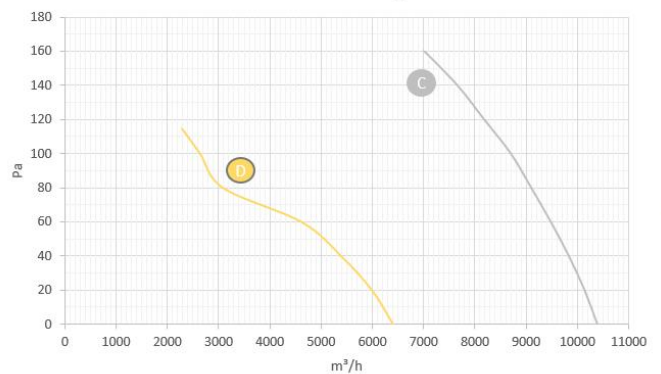

Modello part number	Volt (V)	Frequenza / Frequency (Hz)	Watt in (W)	Corrente / Current (A)	Velocità / Speed (RPM)	Portata / Air flow (m³/h)	Condensatore / Capacitor (µF / V)	Flusso aria / air flow	Db(A)	N	N stat A (%)	Curve
WE5G60(AP)23M451K	230	50	700	3,19	1354	9263	20 / 450	A= aspirante/sucking	74	40,3	33,08	A
WE5G60(AP)23M651E	230	50	313	1,44	929	7263	12 / 450	P= premente/blowing	69	35,8	26,46	B
WE5G60(AP)23T451K	380	50	825	1,56	1365	10397	-	A= aspirante/sucking	75	43,2	36,26	C
WE5G60(AP)23T651K	380	50	259	0,79	948	6411	-	P= premente/blowing	68	40,5	30,52	D

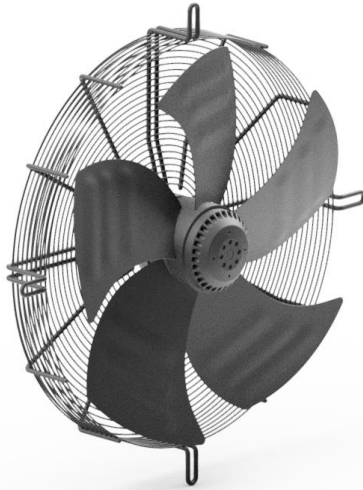

Tipo di servizio: S1
Classe di isolamento: F
Temperatura ambiente: -40°C / +60°C
Classe di protezione: IP54*
Materiale, trattamento superficiale: rotore con foro condensa, verniciato nero, statore protetto contro umidità, griglia verniciata
 I valori di assorbimento si riferiscono alla max efficienza
 *Poichè la nostra produzione viene costantemente migliorata, gli apparecchi potranno differire nei valori e nelle misure illustrate in questa pubblicazione, quindi misure e valori non sono impegnativi

Operating type: S1
Insulation class: F
Ambient temperature: -40°C / +60°C
Protection class: IP54*
Material, surface treatment: rotor with condensation hole, varnished black, humidity proof stator, painted grid
 Absorption values refer to the max efficiency
 *Due to our constant production improvement, technical devices data here indicated could be modified.

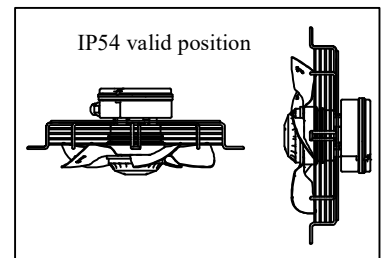
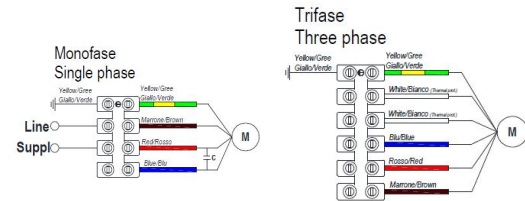
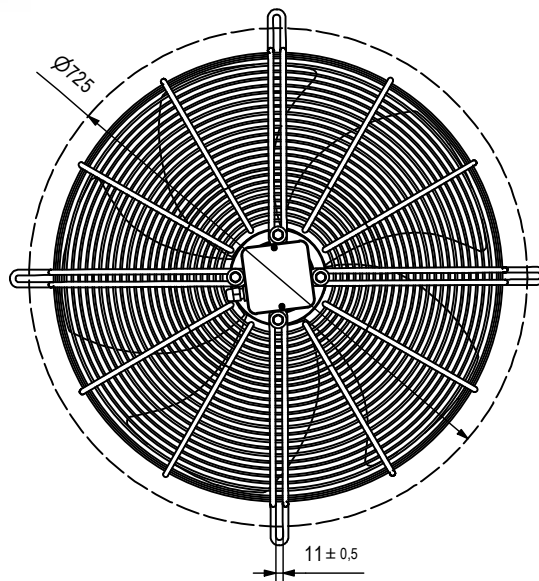
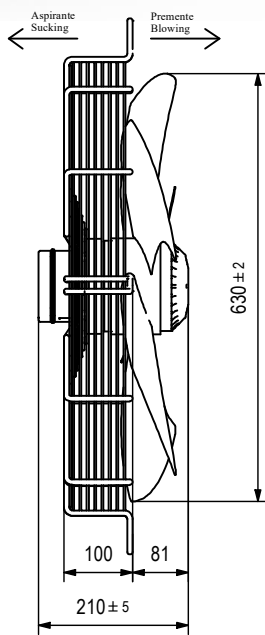

Monofase - Single phase

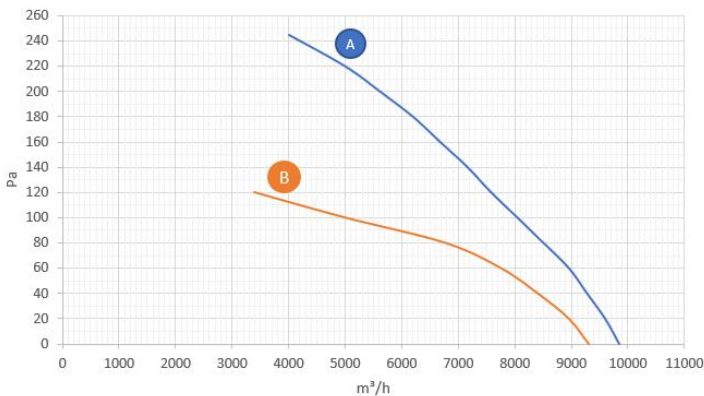

Trifase - three phase

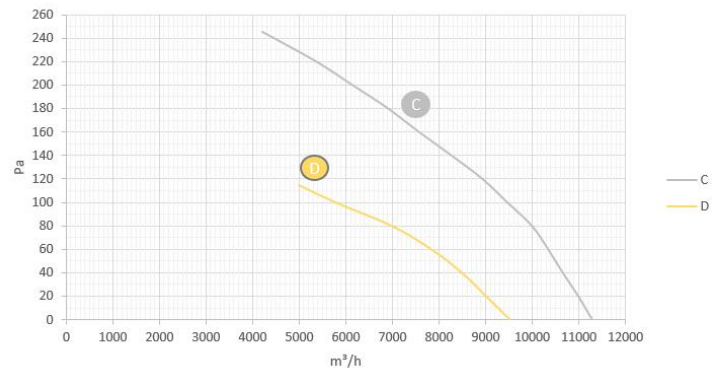

Modello part number	Volt (V)	Frequenza / Frequency (Hz)	Watt in (W)	Corrente / Current (A)	Velocità / Speed (RPM)	Portata / Air flow (m³/h)	Condensatore / Capacitor (µF / V)	Flusso aria / air flow	Db(A)	N	N stat A (%)	Curve
WE5G63(AP)23M451K	230	50	805	3,86	1398	9850	20 / 450	A= aspirante/sucking	75	44,5	37,61	A
WE5G63(AP)23M651K	230	50	479	2,22	916	9300	16 / 450	P= premente/blowing	71	40,7	32,45	B
WE5G63(AP)23T451K	380	50	937	1,75	1378	11300	-	A= aspirante/sucking	77	42,2	35,84	C
WE5G63(AP)23T651K	380	50	485	1,23	925	9533	-	P= premente/blowing	71	41,9	33,7	D



Azienda e Uffici/Factory and offices:

FMI Fan Motors Italia S.r.l.

Via Galileo Galilei, n. 16

21042 Caronno Pertusella (Varese) - Italy

Phone Sales +39.02.96450753

Phone Logistic +39.02.96450781

Phone

Administration +39.02.9659288

Fax +39.02.96450287

sales@fanmotorsitalia.com

www.fanmotorsitalia.com

